

Intellian

i4 Inland

Installation and Operation User Guide

Serial number of the product

This serial number will be required for all troubleshooting or service inquiries.

© 2020 Intellian Technologies Inc. All rights reserved. Intellian and the Intellian logo are trademarks of Intellian Technologies, Inc., registered in the U.S. and other countries. The Intellian i4 Inland is a trademark of Intellian Technologies, Inc. Intellian may have patents, patent applications, trademarks, copyrights, or other intellectual property rights covering subject matter in this document. Except as expressly provided in any written license agreement from Intellian, the furnishing of this document does not give you any license to these patents, trademarks, copyrights, or other intellectual property. All other logos, trademarks, and registered trademarks are the property of their respective owners. Information in this document is subject to change without notice. Every effort has been made to ensure that the information in this manual is accurate. Intellian is not responsible for printing or clerical errors.



Disclaimer

The information in this user manual is subject to change without prior notice through a product life cycle. A printed version of the user manual is periodically updated and may contain inaccuracies or omissions compared to the recent product information. The most up-to-date information is available on our website at <https://www.Intelliantech.com>.

GENERAL PRECAUTIONS	4	OPERATION USING PC CONTROLLER PROGRAM	48
INTRODUCTION	4	INTRODUCTION	48
INTRODUCTION TO INTELLIAN i4 Inland	4	PROGRAM INITIALING AND SERIAL PORT SETUP	49
FEATURES OF INTELLIAN i4 Inland	5	MAIN MENU	50
BASIC SYSTEM CONFIGURATION OF INTELLIAN i4 Inland	6	CONTROLLER MENUS	52
INSTALLATION	7	PREPARATION FOR TRANSPORTATION	60
SYSTEM COMPONENTS	7	WARRANTY	61
TOOLS REQUIRED FOR INSTALLATION	10	APPENDIX : TECHNICAL SPECIFICATION	62
PLANNING THE INSTALLATION	11		
INSTALLATION AND MOUNTING OF ANTENNA	13		
INSTALLING THE ACU	16		
ACU DIMENSIONS	16		
SELECTING ACU INSTALLATION SITE	17		
CONNECTING THE SYSTEM CABLES	18		
CONNECTING THE SYSTEM TO A GPS	21		
ADJUSTING THE LNB SKEW ANGLE (LINEAR POLARIZATION ONLY)	22		
OPERATION INSTRUCTION	23		
INTRODUCTION	23		
OPERATING THE ACU	24		
ACU SOFT KEYS	24		
NORMAL MODE	24		
SETUP MODE	27		

General Precautions

Before you use the antenna, make sure that you have read and understood all safety requirements.

	<p>THIS WAY UP</p> <ul style="list-style-type: none">Place the boxes/crates on the floor noting the direction of the arrow.
	<p>FRAGILE</p> <ul style="list-style-type: none">Since the Radome is fragile, handle it with care. Do not apply excessive pressure or shock. These may cause surface cracking or other damage.
	<p>KEEP DRY</p> <ul style="list-style-type: none">Always make sure the antenna is stored on a dried floor.The antenna can withstand ordinary rain. However its water resistance cannot be guaranteed if submerged.Keep the antenna in a dried place for sufficient ventilation. Do not store the antenna wrapped in a tarp, tent, vinyl, and others.

Introduction

Introduction to Intellian i4 Inland

Intellian Inland is a 45cm digital satellite antenna system designed specifically for only inland marine use. Intellian Inland is ideal for virtually all types of vessels (anchored or transit) to automatically identify, track and capture satellite signals from the Digital Video Broadcasting (DVB: the international standard for digital TV transmissions) compatible satellites.

Specifically, Intellian Inland has a Wide Range Search (WRS) algorithm, which minimizes the search time during initialization, and Dynamic Beam Tilting (DBT) technology, which dynamically shapes the antenna beam to utilize stabilization. Once the satellite is acquired, the antenna DBT continuously measures the heading, pitch, and roll of the vessel by obtaining the satellite signal level around the antenna point, and transmits commands to the antenna motors to keep the antenna pointed at the satellite at all times. This active stabilization is enhanced by a conical scan tracking function to detect and lock onto the strongest signal, resulting in the clearest reception possible.

The Inland has a built-in GPS system which enhances the speed of satellite signals acquisitions.



Features of Intellian i4 Inland

Enjoy satellite broadcasts at sea

Intellian Inland is the most modern antenna system that enables you to receive high quality broadcasting signal at sea where the atmospheric and environmental condition is very harsh.

Fully automatic control system

Fully automatic control system allows you to simply turn the power switch on, and have crystal clear, high quality satellite television in motion or at anchor.

High quality antenna

High tech parabolic antenna technology has been adopted for this antenna system, which is optimal for marine conditions. This enables you to receive the optimal signal level even when it is raining or snowing.

Fast and efficient search for the satellite

The WRS (Wide Range Search) algorithm allows for the antenna system to search the satellite within the shortest amount of time and to detect the satellite signal under any position and with any directional movement of the ship.

Outstanding reliability

Intellian Inland provides highly reliable system through the implementation of a modularized design and the usage of strictly proven components.

Built-in GPS

Intellian Inland has imbedded GPS, which allows for the system to upload the GPS data automatically into the system for an even faster and stable system.

Easy installation

Intellian Inland uses only one RF cable for installation. This makes installation easy. Power, RF, and Data signals transfer from the antenna to the ACU through this single cable.

Compact size

Intellian Inland's small and compact size is perfect for small vessels.

Basic System Configuration of Intellian Inland

For your satellite TV system to function properly, the system will have to be connected with all of the provided components as shown on the right. (Refer to the next chapter 'Installation' in this manual for more detailed connection instructions). Separate purchase of a satellite receiver and a TV is required.

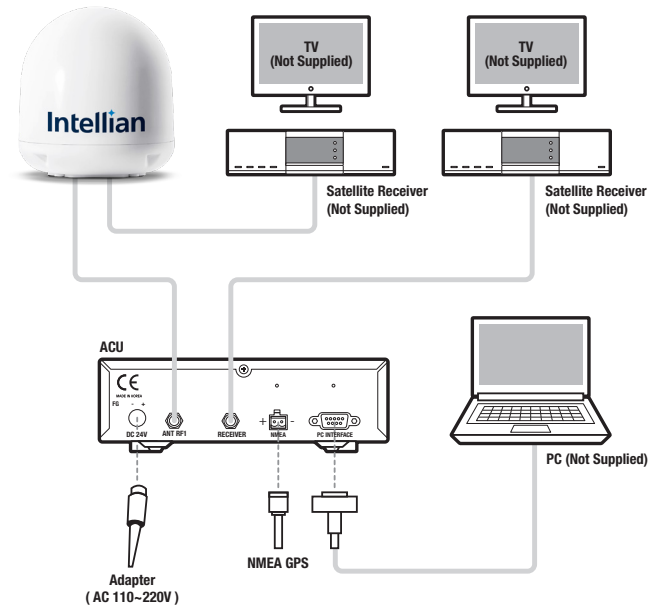

Figure 1 : Basic Configuration

Installation

The components of the Intellian i4 Inland are designed as module system so that it is suitable for simple installation on all types of vessels.

System Components

Antenna Unit

The antenna of Intellian i4 Inland is comprised of the following components for optimum search and receive capabilities for satellite signal.

- Mechanical Unit – manipulates the antenna to receive the optimal satellite signal regardless of the movement of the vessel.
- Control Unit – controls mechanical operation of the antenna.
- RF Unit – transmits the optimum satellite signal to the receiver.
- Radome – protects the antenna from the severe marine environment.



Figure 2 : Radome

Intellian Satellite TV Antenna Systems

Antenna Control Unit (ACU)

The Antenna Control Unit (ACU) provides the power to the antenna and controls the various settings of the antenna. The digital VFD (Vacuum Fluorescent Display) allows for easy operation of the ACU, even in the dark.

The functions of the ACU are as follows:

- Controls the antenna system
- Provides power to the antenna unit
- Monitors the antenna status
- Changes the target satellite
- Set up the user environment
- Set the current GPS information
- Set satellite information
- Move antenna manually
- Perform self-diagnosis of the antenna
- Set up the interface with a PC

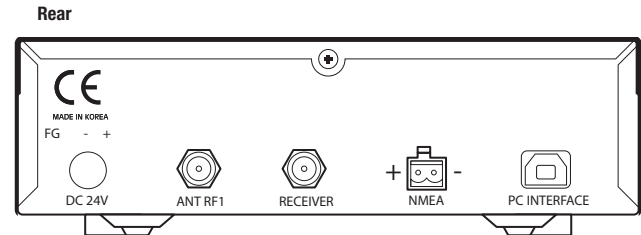

Figure 3 : Front & Rear of ACU

Installation Kit

Contains the items required for securing the antenna unit and ACU to the vessel.





	Antenna		ACU		
Item					
	Hex.Bolt	Spring Washer	Flat Washer	Self-Tapping Screw	Machine Screw
Qty	5	5	5	5	5
Size	-	-	-	(M4 X 16L)	(M3 X 8L)

Figure 4 : Installation Bolt Kit

Other Components

No	Components	Size	Qty
1	ACU Table Mounting Bracket	-	2
2	RG6 (Antenna - ACU RF Cable)	15m	1
3	RG6 (ACU-Receiver Cable)	3m	1
4	Power Cable	1.5m	1
5	PC USB Cable	1.5m	1
6	AC Adaptor	1.5m	1
7	NMEA Connector	AK950-2	1
	Hex Bolt	M8x35L	5
	Tapping Screw	ø4x16L	5
8		ø3x8L	5
	Flat Washer	M8	5
	Spring Washer	M8	5
	Installation CD	-	1
9	Mounting Template	-	1
10	Installation Plate	-	1
11	Quick Installation Guide	-	1

Figure 5 : List of the Supplied Parts

Tools Required for Installation

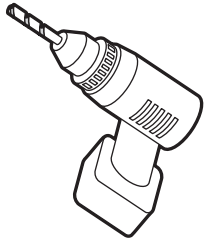

Power Drill

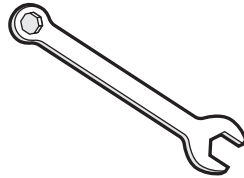

11 mm Spanner

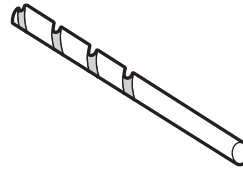

10 mm Drill Bit

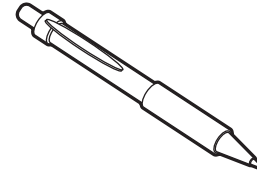

Pencil

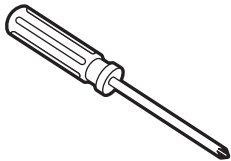

**Cross-Head
Screwdriver**

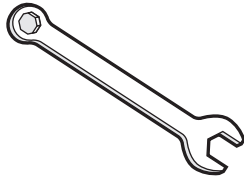

13 mm Spanner

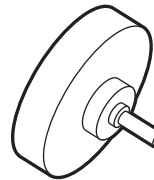

**Ø80 mm
Hole Saw**

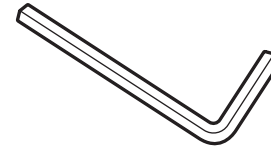

**5 mm
Allen/Hex key**

Figure 6 : Required Tools for Installation

Planning the Installation

Antenna Unit

Install the antenna in accordance with the following procedures to insure maximum performance of the antenna. The antenna should be installed in the place where is an all round clear view of the horizon. Please be sure there are no obstacles within 15 degrees above the antenna. Any obstacles can prevent the antenna from tracking the satellite signal (Refer to the drawing on the right).

Do not install the antenna near by the radar especially on the same plane as their energy levels may overload the antenna front-end circuits. It is recommended to position the antenna at least 4 feet (1.2m) above or below the level of the radar and minimum of 15 feet (6m) away from the high power short wave radars.

The mounting platform should be rigid enough and not subjected to excessive vibration. The movement of the antenna can be minimized by installing at the center of the vessel. For optimal performance of the antenna, it is not recommended to install at any corner of the vessel, where the movement of the vessel is the greatest. Install the bottom of the antenna parallel to the surface of the sea and fix tightly to the structure of the vessel. When setting the antenna down, be careful not to damage the RF connector. Striking the connectors on the bottom directly will damage the connector.

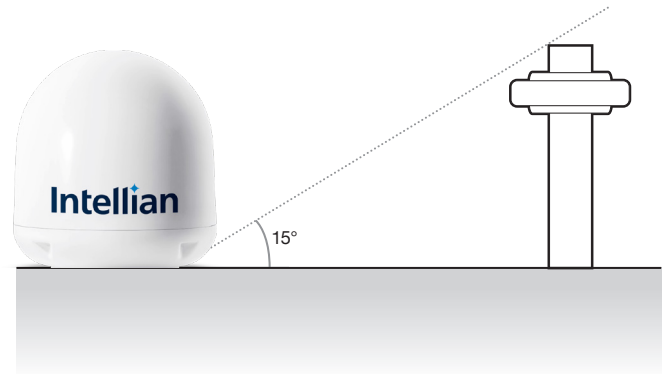

Figure 7 : Elevation Limit of Obstacles

Intellian Satellite TV Antenna Systems

Cables

Before installing the system cables, consider the following points.

- All cables need to be well clamped and protected from physical damage and exposure to heat and humidity.
- Cables with severe bends are not allowed.
- Where a cable passes through an exposed bulkhead or deckhead, a watertight grommet or swan neck tube should be used.

Power Requirements

You need to follow the power requirements to avoid damaging the system.

- Intellian Inland comes with an AC Power Adapter designed to a boat's power supply rated from 110~220 V AC.
- If your Receiver(s) and television(s) require a 110V/240V AC power supply, you will need to install a suitable DC to AC converter to operate the units from your boat's DC power supply.

Extending the cables

The cables that have been supplied with your Intellian system should be of adequate length to complete the installation on most boats.

Power Adapter

The supplied power adapter supports a power supply rated from 110~220V AC.

RF Cable

This cable is supplied at a length of 15m. If a longer length is required you should replace this cable with an extended RF cable supplied by Intellian Technologies.

Note: Exceeding the indicated cable lengths will result in reduced performance of your system.

Installation and Mounting of Antenna

The method of installation and mounting of antenna may vary due to vessel design but the following procedures are applicable in most situations, and will result in a secure and effective installation.

Confirmation of Size Prior to Installation

- Confirm the height and diameter of the bottom surface of the antenna before installing it.
- The space must be sufficient for installing the antenna unit considering the height and diameter of the antenna.
- The height and the diameter of the bottom surface of the antenna are as shown in the following drawing. If possible, install the antenna using a power tower.

Note: Before installing the antenna, open the radome and remove the shipping constraints from the antenna interior. Reinstall the radome before operating the system. The system will not perform properly if the radome is open.

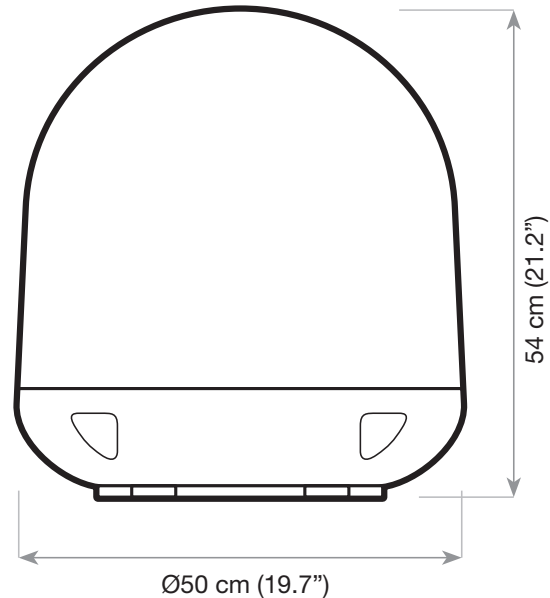

Figure 8 : Radome Dimension of i4 Inland

Mark of the Antenna Mounting Position

Referring to the mounting template, mark where the antenna is to be mounted on board the ship (it must be a flat surface) or on a separate power tower by the drawing on the right.

Note: If a power tower is not used to mount the antenna, separate cable shocks and waterproofing measures must be taken to protect the RF connector from being exposed to sea water and external shocks. An exposed cable may cause electric shock and cause serious damage to the equipment.

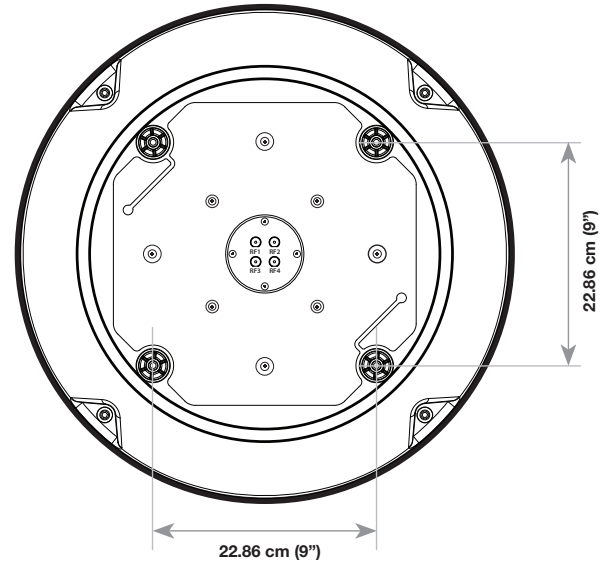

Figure 9 : Mounting Hole Position of i4 Inland

Securing Holes for Bolts and Cable Ways

Make 4 bolt holes of 10mm diameter, one at each corner of a rectangle drawn as below, and make a circular hole of 80mm diameter at the center of the rectangle through which the cable will run.

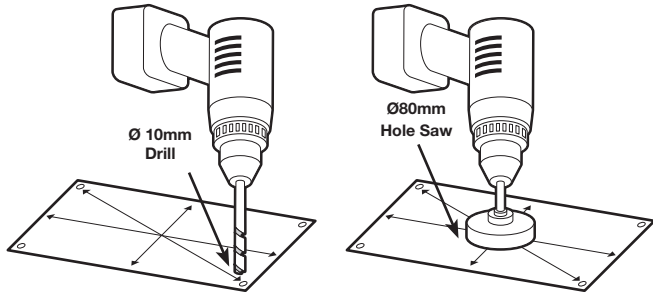

Figure 10 : Drilling Instruction

Connection of the Cable

Remove the rubber cap from RF connector. Connect the RF cable to the RF connector under the base plate through the access hole using an 11mm spanner. Be careful not to over tighten, as you may damage the connector.

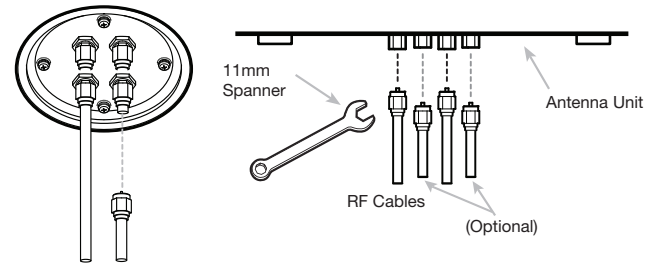

Figure 11 : Connectors on Bottom of Antenna

Note: Do not tighten excessively when using the spanner, this will damage the threads. Be careful that the connectors do not touch the mounting surface of the antenna, this might cause a critical malfunction and serious damage to the equipment.

Mounting the Antenna

Attach the antenna by using the hex head bolts (M8X35L), M8 spring washers, and M8 flat washers supplied.

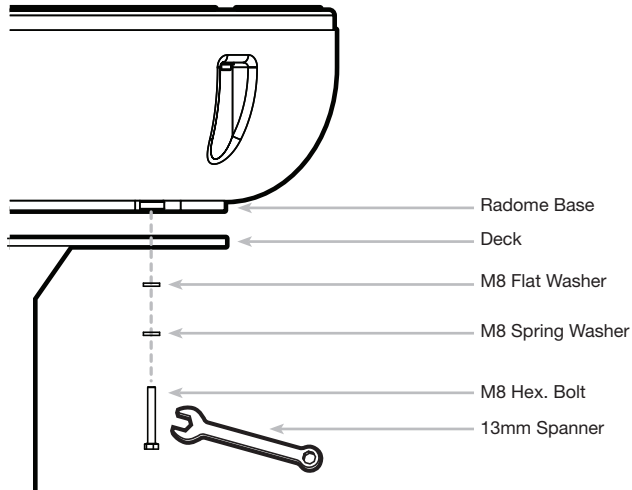

Figure 12 : Mounting the Antenna

Installing the ACU

ACU Dimensions

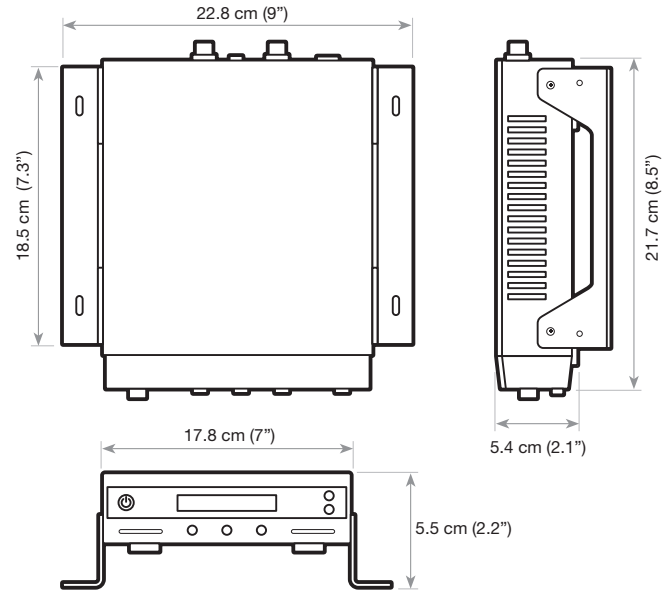

Figure 13 : Dimension of ACU

Selecting ACU Installation Site

The ACU should be installed below deck, in a location that is:

- Dry, cool, and ventilated.
- Easy access from your main TV viewing area.

To Install the ACU

1. The ACU should be installed using the two supplied mounting brackets which allow for a top or bottom mounting configuration.
2. Using the self tapping screws supplied, attach the mounting brackets to the sides of the ACU.
3. Place the ACU in the location where it is going to be installed.
4. Connect the cables to the rear of the ACU.
5. Use a pencil to mark the 4 hole positions (two on each side), and use the appropriate drill bit to drill.

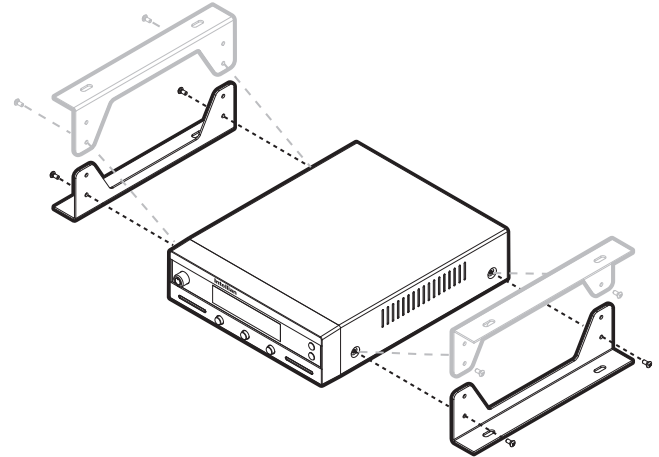

Figure 14 : Installation of ACU

Connecting the System Cables

After installation and fixation of the antenna, connect the ACU to the antenna. Refer to the drawing below to connect cables.

Antenna RF Cable (Connecting Antenna - ACU)

Intellian provides the Antenna RF Cable (RG-6, 15 m) for connecting Antenna and ACU. Due to the signal losses across the length of the RF coax on L-Band, Intellian recommends the following **75 Ω** coax cable types for standard system installations. Check the instructions from the cable supplier. The table below shows the recommended cable types and maximum cable lengths for the antenna system. For installing cables longer than the recommended length, consult with Intellian Technologies first.

RF Cable Recommendation

Coaxial Cable Type	Max. Cable Length
RG-6/U Solid Copper Core or LMR 300	35 m
RG-11/U Solid Copper Core or LMR 400	60 m
LMR 600	100 m

Single Receiver Connection

1. Connect the RF cable 15m from the RF 1 connector on the antenna base plate to the ANT. RF1 connector on the ACU.
2. Connect the RF cable 3m from the RECEIVER connector on the ACU to RF connector on the Receiver.
3. Connect the DC power cable 1.5m from DC power connector on the ACU to a power source from 110~220V AC.
4. Press the POWER ON switch on the ACU to start the operation of the antenna system.

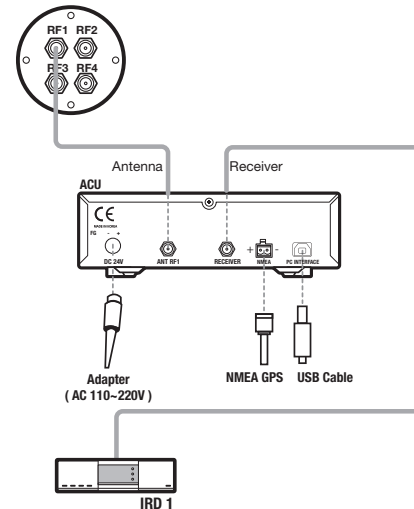

Figure 15 : Single Receiver Configuration

Twin Receivers Connection

You can connect two Receivers for your antenna as shown in the following diagram. However, only one of the Receivers can be configured as a two satellite receiver.

The other Receiver needs to be configured as a one satellite receiver. The two satellite receiver determines which satellite is tracked, while the other receiver can watch any channel which is available from the tracked satellite.

As in the single Receiver option the RF cables from the antenna base plate should be connected to 'LNB', 'ANT', or 'Satellite In' on the rear panel of Receiver.

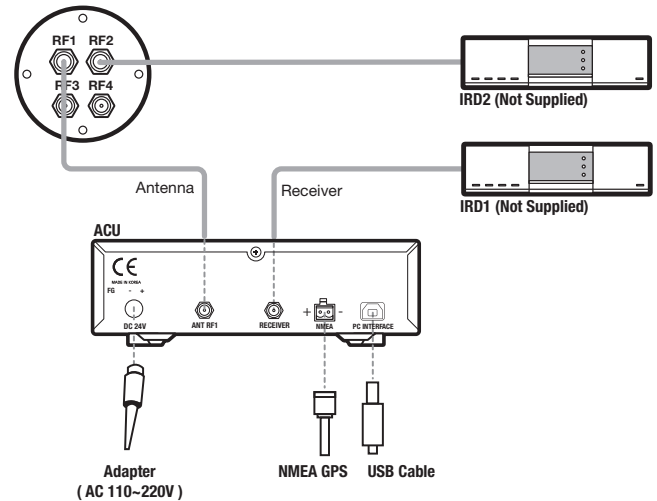
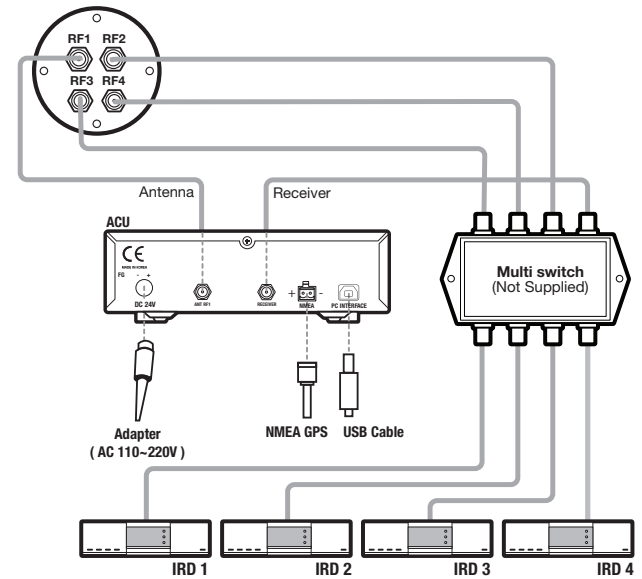

Figure 16 : Twin-Receiver Configuration

Multi-Receiver Connection

In order to connect multiple Receivers to the antenna, you will need to purchase a suitable LNB multiswitch. The multiswitch has to be installed between the antenna unit and the Receivers as shown in the following diagram.



* IRD 1~4 : Not supplied

Figure 17 : Multi-Receiver Configuration

Connecting the System to a GPS

Your satellite TV system has a built-in GPS. If the internal GPS doesn't operate properly, you can directly connect your boat's NMEA 0183 GPS to the system through the ACU's external GPS connector. To do this you will need a suitable cable to connect your GPS system and the green 2-way ACU GPS connector supplied with your Intellian i4 Inland Satellite TV System.

To Connect the System to a GPS

1. Strip back the insulation of each cable and connect a cable to each terminal of the 2-way connector.
2. Tighten the locking screws.
3. Connect the cable from the + (positive) terminal of the ACU GPS connector to the NMEA OUT wire of the vessel's GPS system.
4. Connect the cable from the - (negative) terminal of the ACU GPS connector to the Ground Wire of the vessel's GPS system.
5. Refit the ACU GPS connector to the rear of the ACU.

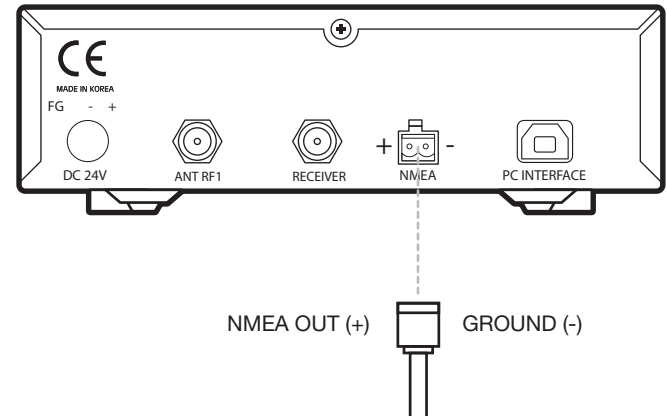

Figure 18 : NMEA 0183 GPS Connection

Adjusting the LNB Skew Angle

(Linear Polarization Only)

LNB Skew Angle

The LNB skew angle only needs to be adjusted when the target satellite is linear polarized. In order to receive the maximum satellite signal level, the LNB skew angle must be adjusted according to the calculation of current GPS location and target satellite.

It only needs to be adjusted when changing from one satellite to another, or when the vessel has traveled a significant geographic distance. It should NOT need to be readjusted if the vessel stays in the same location and is operating on the same satellite.

Adjust Skew angle Manually

Polarization of your Intellian i4 Inland antenna must be accomplished manually by the following steps.

- Remove the upper part of Radome after switching power OFF.
- Loosen 4 bolts of the connection of LNB and feed horn.
- Turn LNB to place it to the angle indicated on the back of the feed horn.
- Tighten the 4 bolts.

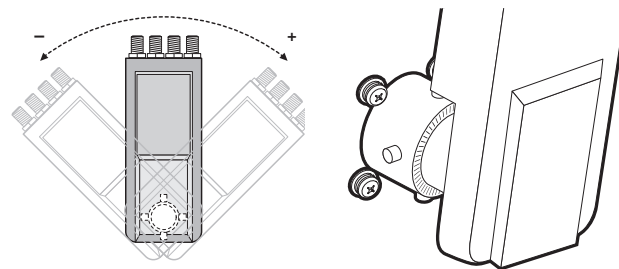

Figure 19 : Manual LNB Skew Angle Adjustment

Operation Instruction

Introduction

This section of the handbook describes how to setup your Satellite TV System after installing the ACU. It includes the following functions:

- System start up.
- Changing the default satellite.
- Monitoring the antenna status.
- Setting sleep mode.
- Entering setup mode.
- Setting the satellite pair.
- Editing satellite information.
- Setting the antenna parameter.
- Setting the LNB local frequency.
- Setting GPS.
- Setting the DiSEqC method.
- Display versions.
- Display power status.
- Setting antenna go position.
- Setting antenna move step.
- Setting remote control.
- Setting the factory default parameters.
- Performing diagnostic tests.

Note: Many of the above functions will only be required only after initial installation of your system. Refer to the Quick Installation Guide before operating the system.

Operating the ACU

ACU Soft Keys

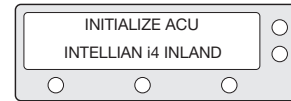

Figure 20 : ACU Soft Keys

Normal Mode

Start Up

With the system installed and power applied, the ACU screen will show the following sequence:



1. Data communication is being established between the antenna and the ACU. The ACU is initialized.

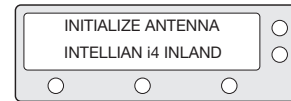

2. The antenna is initialized.

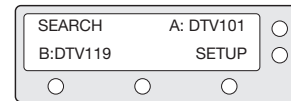

3. The antenna is searching for Satellite A.

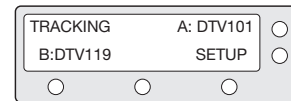

4. The antenna has located the satellite and is now tracking.

Changing Target Satellite

Your antenna is programmed with either two (Dual-Sat mode) or three (Tri- Sat mode) candidates of target satellites as default mode. To change the target satellite, press LEFT soft key. The target satellite is changed and is automatically tracked by the antenna.

Dual-Sat Mode

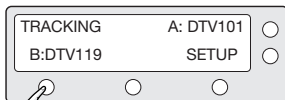

1. Press LEFT soft key for tracking Satellite B.

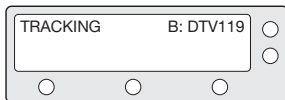

2. The antenna is tracking Satellite B.

Advanced Tri-Sat Mode

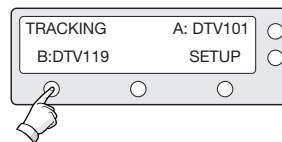

1. Press LEFT soft key for tracking Satellite B.

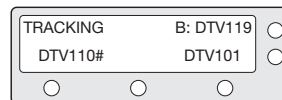

2. The antenna is tracking Satellite B.

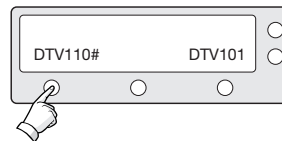

3. Press LEFT soft key for tracking Satellite C.

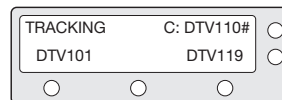

4. The antenna is tracking Satellite C.

Intellian Satellite TV Antenna Systems

Monitoring the Current Status of the Antenna

While POWER ON to Intellian Inland, ACU displays the status of the antenna. The various ACU displays may be shown according to the current status of the antenna.

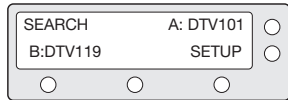

1. The antenna is searching Satellite A.



2. The antenna is tracking Satellite A.

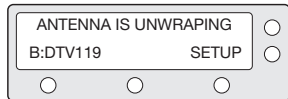

3. The antenna is winding/unwinding the cables in the antenna.

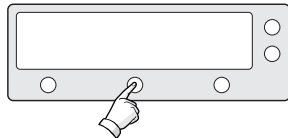

4. The antenna is again tracking Satellite
A. Press center soft key to display position detail.



5. Antenna position detail and signal strength are displayed.

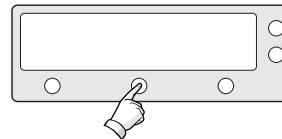

6. Press center soft key to display current GPS information. Press center soft key to return to main tracking mode.

Sleep Mode

If the antenna loses the tracking satellite while in sleep mode, sleep mode will be cancelled.

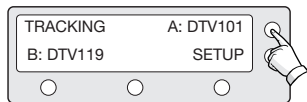

1. Press BACK to enter sleep mode.



2. Press BACK again for exiting sleep mode.

Setup Mode

Begin Setup Mode

To enter the Setup Mode simply follow the instructions below.

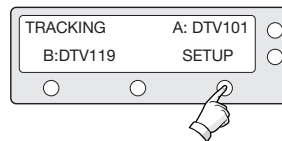

1. While the antenna is tracking press SETUP.

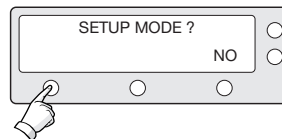

2. Press YES to enter setup mode.

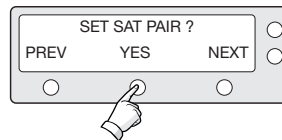

3. Press YES to set the satellite pair.

Intellian Satellite TV Antenna Systems

Setting the Satellite Pair

You can change the satellite pair if you decide to receive satellite television service from a different service provider.



1. Press YES to enter setup mode.

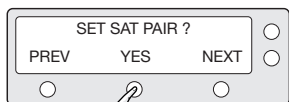

2. Press YES to set satellite pair.



3. Press YES to set triple satellites.

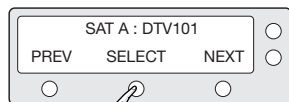

4. Set satellite A
Press PREV to show previous satellite name.
Press SELECT to set chosen satellite to SAT A.
Press NEXT to show next satellite name.

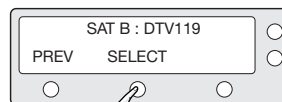

5. Set satellite B
Press PREV to show previous satellite name.
Press SELECT to set chosen satellite to SAT B.
Press NEXT to show next satellite name.

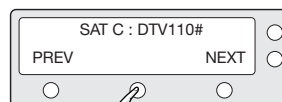

6. Set satellite C
Press PREV to show previous satellite name.
Press SELECT to set chosen satellite to SAT C.
Press NEXT to show next satellite name.



7. Press YES to save selections.
Press NO to cancel and return to main setup mode.

Setting GPS

It is possible to set up and modify the GPS information, which enhances the antenna functionality.



1. Press YES to enter setup mode.

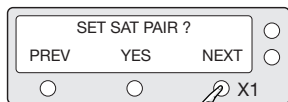

2. Press NEXT to enter GPS setup mode.

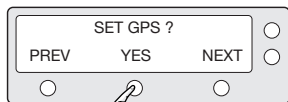

3. Press YES to set GPS.

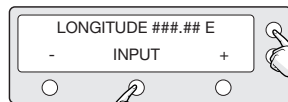

4. Input the longitude data.
+ increases the value. - decreases the value.
Change the underscored digit using the +/- buttons.
Press INPUT to accept the value and move to next digit. Press BACK to move to previous digit.

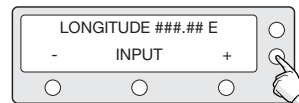

5. Press ENTER to move to next screen.
Press BACK to move to previous screen.

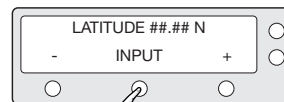

6. Input the latitude data.
+ increases the value. - decreases the value.
Change the underscored digit using the +/- buttons.
Press INPUT to accept the value and move to next digit.
Press BACK to move to previous digit.



7. Press YES to accept data.
Press NO to cancel and return to main setup mode.

Intellian Satellite TV Antenna Systems

Edit Satellite Information

It is possible to modify the existing satellite information and input new satellite information into the ACU as well. It is not recommended for a novice satellite service user to use this mode.



1. Press YES to enter setup mode.

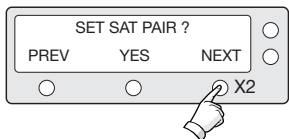

2. Press NEXT twice to enter edit satellite info mode.

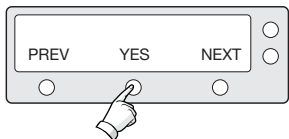

3. Press YES to edit satellite info.

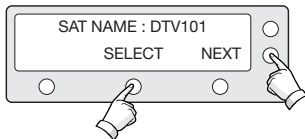

4. Set the satellite name.
PREV - Shows previous satellite name.
SELECT - Select the displayed satellite for editing.
NEXT - Shows next satellite name.
Press ENTER to move to next screen.

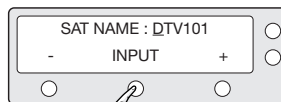

5. Input the satellite name.
+ increases the value. - decreases the value.
Change the underscored digit using the +/- buttons.
Press INPUT to accept the value and move to next digit.
Press BACK to move to previous digit.

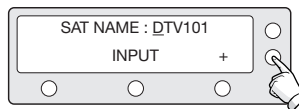

6. Press ENTER to move to next screen.
Press BACK to return previous screen.

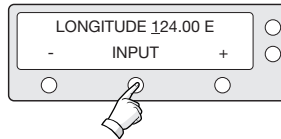

7. Input the satellite position.
+ increases the value. - decreases the value.
Change the underscored digit using the +/- buttons.
Press INPUT to accept the value and move to next digit.
Press BACK to move to previous digit.

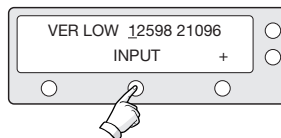

8. Input the tracking frequency (MHz) and symbol rate (KHz) for vertical low band.

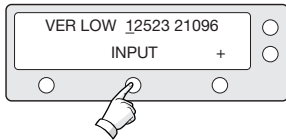

9. Input the network ID (NID) for vertical low band.

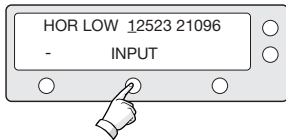

10. Input the tracking frequency (MHz) and symbol rate (KHz) for horizontal low band.

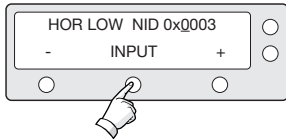

11. Input the network ID (NID) for horizontal low band.

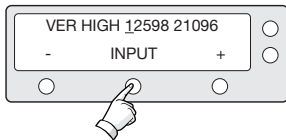

12. Input the tracking frequency (MHz) and symbol rate (KHz) for vertical high band.

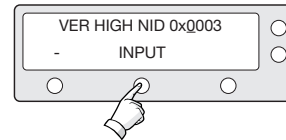

13. Input the network ID (NID) for vertical high band.

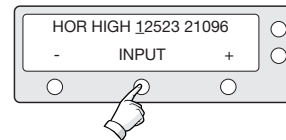

14. Input the tracking frequency (MHz) and symbol rate (KHz) for horizontal high band.

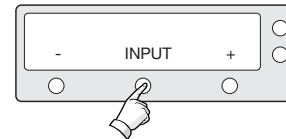

15. Input the network ID (NID) for horizontal high band.

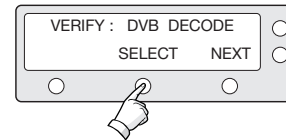

16. Select the **Verification Method*** of tracking satellite.
PREV - Shows previous method.
SELECT - Set the displayed method.
NEXT - Shows next method.

Intellian Satellite TV Antenna Systems

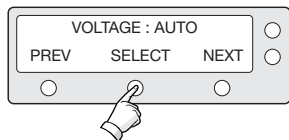

17. Select the **Voltage Supply Method*** to LNB.
(AUTO is recommended)

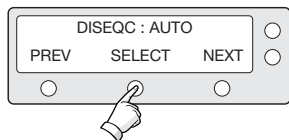

18. Select the **DISEQC Method***.
(AUTO is recommended)



19. Press YES to save the input information.
Press NO to cancel and return to main setup mode.

Verification Method*

SIGNAL - use only signal level for tracking
DVB LOCK - use only DVB Lock signal for tracking
DVB DECODE - verify satellite using DVB decoding method for tracking
DSS DECODE - decode only DSS Lock signal for tracking
AGC AFTER DECODE - for tracking Ka-Band satellite

Voltage Supply Method*

AUTO – Supply 13V or 18V to LNB
ONLY 13 V - always supply 13 V to LNB
ONLY 18 V - always supply 18 V to LNB

DISEQC Method*

AUTO – Supply 0KHz tone or 22KHz tone to LNB
ONLY 0 KHz – always supply 0KHz tone to LNB
ONLY 22 KHz – always supply 22KHz tone to LNB

Setting the Antenna Parameters

It is not recommended for a novice satellite service user to use this mode. Consult Intellian for changing antenna parameters.

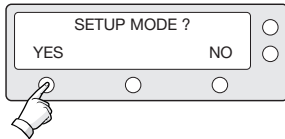

1. Press YES to enter setup mode.

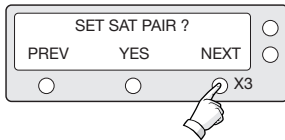

2. Press NEXT three times to enter set antenna parameter mode.

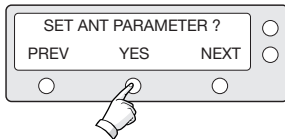

3. Press YES to set antenna parameter.

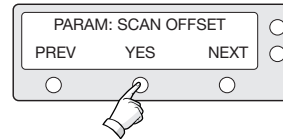

4. Select the **PARAM***.

PREV - Shows previous parameter.
SELECT - Set the displayed parameter.
NEXT - Shows next parameter.
Press ENTER to move to next screen.

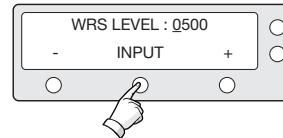

5. Input the local frequency of LNB.

+ increases the value. - decreases the value.
Change the underscored digit using the +/- buttons.
Press INPUT to accept the value and move to next digit.
Press BACK to move to previous digit.
Press ENTER to move to next screen.



6. Press YES to save the input information.
Press NO to cancel and return to main setup mode.

Intellian Satellite TV Antenna Systems

PARAM*

Scan Offset The scan offset is to offset the angle difference between the black marker on the sub-reflector and the optical sensor.

Track Scale The track scale is to control the tracking speed while antenna is tracking the satellite.

Detect Level The detect level is to set the satellite signal detection level.

WRS Level The WRS level is to set the WRS detection level.

Track Offset The tracking offset is to offset the satellite signal tracking level.

Power Level The power level is to distinguish the voltage between 13 V and 18 V.

DiSEqC Level The DiSEqC level is to distinguish 0KHz tone and 22KHz tone.

Offset RH-LH The offset RH-LH is to offset the signal difference between RHCP and LHCP.

EL Offset The EL offset is to offset the angle difference between the mechanical elevation angle and actual elevation angle.

Use WRS Use WRS is to determine whether the system uses WRS level or not. "Use WRS" and "WRS Level" are pair functions.

Offset Difference Offset difference is to determine whether the system to uses "Offset RH-LH" or not. "Offset Difference" and "Offset RH-LH" are pair functions.

Setting the LNB Local Frequency

It is possible to select a local frequency from ACU. It is not recommended for a novice satellite service user to use this mode.

Case1. Single band LNB is used.

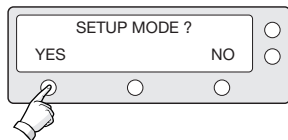

1. Press YES to enter setup mode.

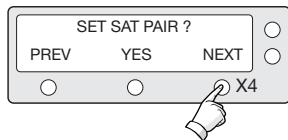

2. Press NEXT four times to enter set local frequency mode.

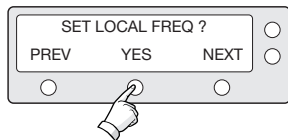

3. Press YES to set local frequency.

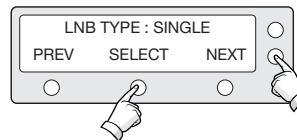

4. Select the **LNB Type*** - SINGLE.
PREV - Shows previous LNB type.
SELECT - Set the displayed LNB type.
NEXT - Shows next LNB type.
Press ENTER to move to next screen.

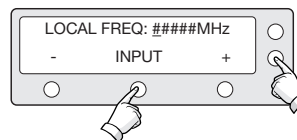

5. Input the local frequency of LNB.
+ increases the value. - decreases the value.
Change the underscored digit using the +/- buttons.
Press INPUT to accept the value and move to next digit.
Press BACK to move to previous digit.
Press ENTER to move to next screen.



6. Press YES to accept the data.
Press NO to cancel and return to main setup mode.

Case 2. Universal LNB is used (Low band local frequency-9750 MHz/ High band local frequency 10600 MHz).

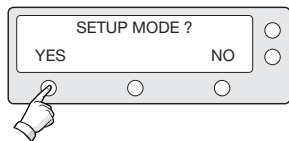

1. Press YES to enter setup mode.

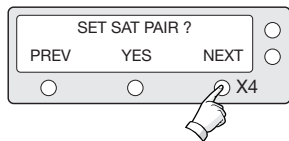

2. Press NEXT four times to enter set local frequency mode.

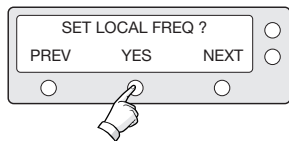

3. Press YES to set local frequency.

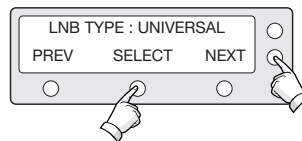

4. Select the **LNB Type*** - UNIVERSAL.
PREV - Shows previous LNB type.
SELECT - Set the displayed LNB type.
NEXT - Shows next LNB type.
Press ENTER to move to next screen.



5. Press YES to accept the data.
Press NO to cancel and return to main setup mode.

LNB Type*

SINGLE: Single Band LNB

Asia 11300 MHz, Japan 10678 MHz, Korea 10750 MHz,
America 11250 MHz

UNIVERSAL : Universal LNB

Low band local frequency - 9750 MHz

High band local frequency - 10600 MHz

Setting the DiSEqC Method

DiSEqC selection can be made from ACU. It is not recommended for a novice satellite service user to use this mode.



1. Press YES to enter setup mode.



2. Press NEXT five times to enter DiSEqC mode.

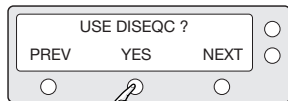

3. Press YES to use DiSEqC.

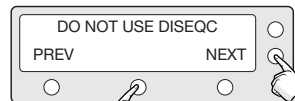

4. Select the **DiSEqC Method***

PREV - Shows previous DiSEqC Method.
SELECT/ENTER - Set the displayed DiSEqC method.

NEXT - Shows next DiSEqC Method.
Press ENTER to move to next screen.



5. Press YES to accept the selection.

Press NO to cancel and return to main setup mode.

DiSEqC Method*

DO NOT USE DiSEqC - DiSEqC is not being used.

USE TO CHANGE BAND - DiSEqC is being used to change to low and high band.

USE TO CHANGE SAT - DiSEqC is being used to change tracking satellite.

Intellian Satellite TV Antenna Systems

Display Versions

This sequence enables you to see what type of antenna and ACU software are installed on your system.



1. Press YES to enter Display Version.

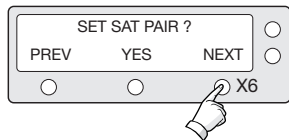

2. Press NEXT six times to enter the View Version mode .

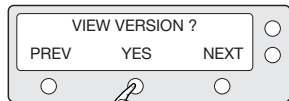

3. Press YES to view version.

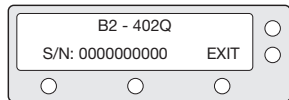

4. Antenna product name and S/N are shown.
Press center soft key to view antenna software version.

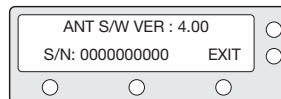

5. Antenna software version and S/N are shown.
Press center soft key to view ACU software version. Press EXIT to return to main setup mode.

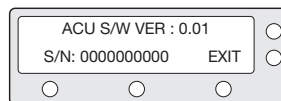

6. ACU software version and S/N are shown.
Press EXIT to return to main setup mode.

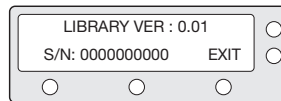

7. Library version and S/N are shown.
Press EXIT to return to main setup mode.

Display Power

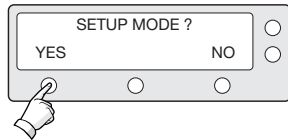

1. Press YES to enter setup mode.

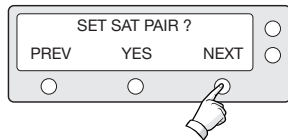

2. Press NEXT seven times to enter the view power mode.

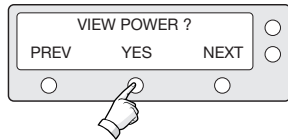

3. Press YES to view power.

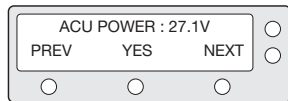

4. ACU input voltage is shown.
Press center soft key to view antenna voltage.
Press EXIT to return to main setup mode.

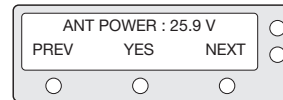

5. Antenna voltage is shown.
Press center soft key to view Receiver Voltage and frequency.
Press EXIT to return to main setup mode.

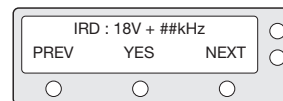

6. Receiver voltage and frequency are shown.
Press EXIT to return to main setup mode.

Setting Remote Control

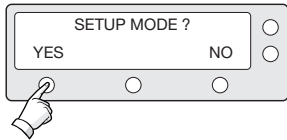

1. Press YES to enter setup mode.

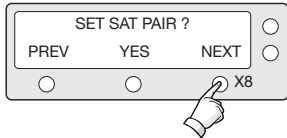

2. Press NEXT eight times to enter remote control setting mode .

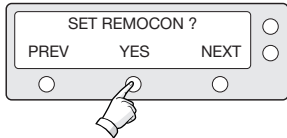

3. Press YES to set remote control.

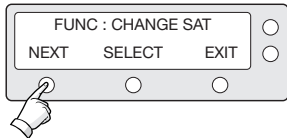

4. Select the **Function***
NEXT - Shows next function.

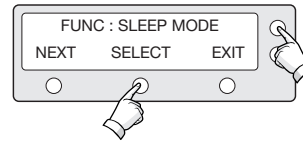

5. **SELECT/ENTER** - Registers a key on remote control.



6. Point remote control to ACU.
Press any key on remote control for selected function and press the same key again for confirmation. Press BACK to move to previous screen.
Press EXIT to return to main setup mode.

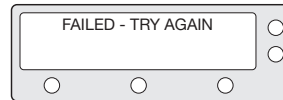

7. If failed to press the same key twice, TRY AGAIN will be displayed.

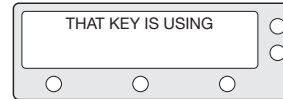

8. If failed to register a free key, KEY IS USING will be displayed.

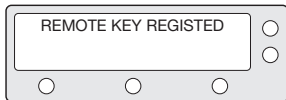

9. REMOTE KEY REGISTERED will be displayed if key has been properly registered.

Function*

CHANGE SAT - Change the target satellite.

SLEEP MODE - Enter sleep mode.

CLEAR REGISTERED KEY - Clear registered key.

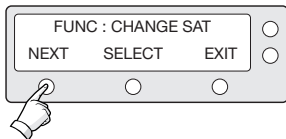

10. Press NEXT to shows next function.
Press EXIT to return to main setup mode.

Setting Antenna Go Position

The antenna can be controlled manually by using the ACU.

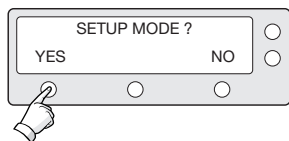

1. Press YES to enter setup mode.

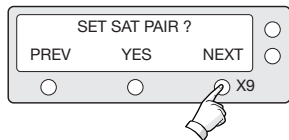

2. Press NEXT nine times to enter Antenna Go Position mode.

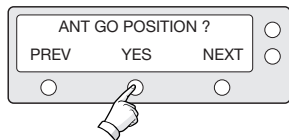

3. Press YES to go position.

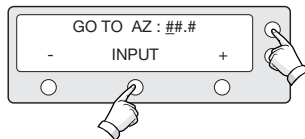

4. Input position value for azimuth (AZ) axis.
+ increases the value. - decreases the value.
Change the underscored digit using the +/- buttons.
Press INPUT to accept the value and move to next digit.
Press BACK to move to previous digit.
Press ENTER to move to next screen.

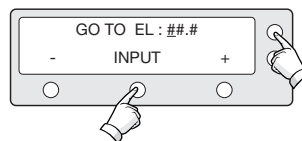

5. Input position value for elevation (EL) axis.
+ increases the value. - decreases the value.
Change the underscored digit using the +/- buttons.
Press INPUT to accept the value and move to next digit.
Press BACK to move to previous digit.
Press ENTER to move to next screen.

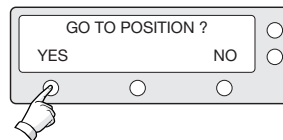

6. Press YES to move the antenna to input position.
Press NO to return to the Antenna Go Position mode.

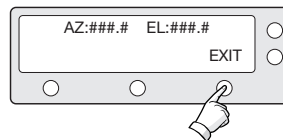

7. Press EXIT to return to main setup mode.

Setting Antenna Move Step

The antenna can be moved by 1° step manually by using ACU.

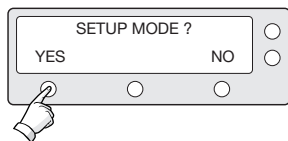

1. Press YES to enter setup mode.

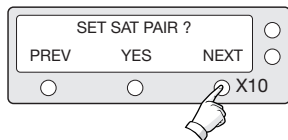

2. Press NEXT ten times to enter antenna move step mode.

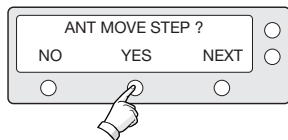

3. Press YES to move step.

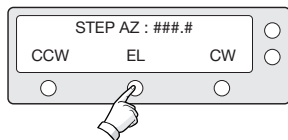

4. Move the antenna in the AZ axis.
CW - Move the antenna clockwise.
CCW - Move the antenna counter clockwise.
EL - Go to elevation control screen.

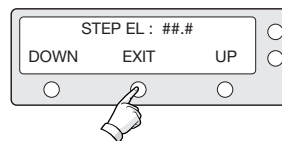

5. Move the antenna in the EL axis.
UP - Move the antenna up.
DOWN - Move the antenna down.
EXIT - Return to antenna move step mode.

Intellian Satellite TV Antenna Systems

Executing Antenna Diagnosis

The antenna status can be checked by reviewing the results of the diagnostic self-test of the antenna. Refer to the following codes to understand the test results.

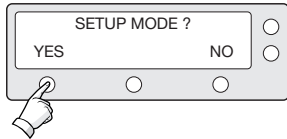

1. Press YES to enter setup mode.

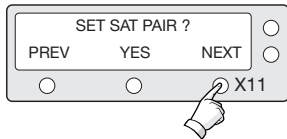

2. Press NEXT eleven times to enter antenna diagnosis mode.

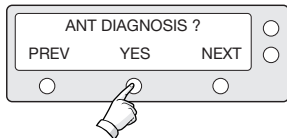

3. Press YES to diagnose antenna.

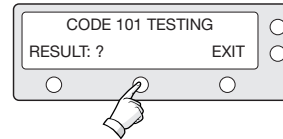

4. CODE 101 is being tested.
Press EXIT to return to main setup mode.

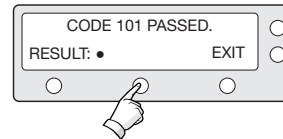

5. **CODE*** 101 has passed.
Press EXIT to return to main setup mode.

CODE*

CODE 101 Data communication between antenna and antenna control unit is tested. If failed, check the RF cable.

CODE 102 AZ CW limit is tested.
If failed, check the limit sensors, motor and belt for AZ axis.

CODE 103 AZ CCW limit is tested.
If failed, check the limit sensors, motor and belt for AZ axis.

CODE 104 EL axis is tested.
If failed, check the limit sensors, motor and belt for EL axis.

CODE 105 Sub reflector is tested.
If failed, check the sub reflector.

CODE 106 LNB is tested.
If failed, check the LNB and control board.

CODE 107 Skew System is tested.
if failed, check the control board, skew motor, and skew sensor.

CODE 108 Antenna Input Power is tested.
If failed, check the RF cable.

CODE 109 ACU Power is tested.
If failed, check the ACU power cable and Input DC power.

CODE 110 Receiver Power is tested to Receiver cable and Receiver power.
If failed, check the ACU to Receiver cable and Receiver power.

RESULT

- Test is passed.

STATUS

- Test is skipped.
- ? Test is under process.

Number refers to an error code
(●●3●●● -●●●) 3 means error code 103.

Setting Region

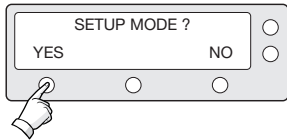

1. Press YES to enter setup mode.

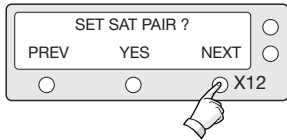

2. Press NEXT twelve times to enter load region information mode.

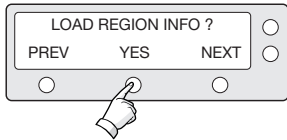

3. Press YES to load region information.

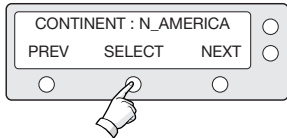

4. Select the **Continent***.
PREV - Shows previous continent.
SELECT - Set the displayed continent.
NEXT - Shows next continent.

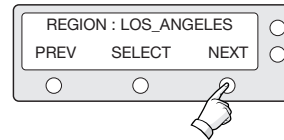

5. Select the **Region***.
PREV - Shows previous region.
SELECT - Set the displayed region.
NEXT - Shows next region.

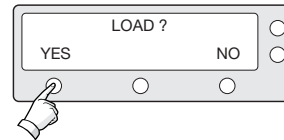

6. Press YES to load region information.
Press NO to cancel and return to main setup mode.



7. Loading selected region information.

Continent*
N. AMERICA, S.AMERICA, EUROPE, ASIA.

Region*
NEW YORK, MIAMI, UK, JAPAN, and etc.

Setting the Factory Default Parameters

This will restore the antenna back to factory default setting.

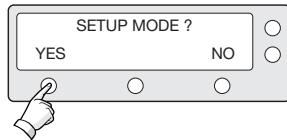

1. Press YES to enter setup mode.

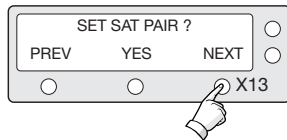

2. Press NEXT thirteen times to enter Default setting mode.

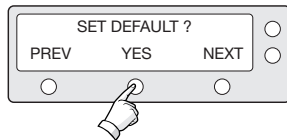

3. Press YES to set default parameters.

Operation Using PC Controller Program

Introduction

GUI Software of Intellian i3/i3L/i4/i4P has been created for the user to easily set up the antenna by using the user's personal computer. Using the GUI program enables the user to easily monitor and modify the information of antenna, satellite and GPS. Additionally, the detailed diagnostic methods of the antenna are provided by the GUI program.

To start this GUI program,

1. Connect one end of PC serial cable to the serial port on the computer.
2. Connect the other end of the PC serial cable to the "PC INTERFACE" on the rear of ACU.
3. Execute GUI program by inserting the supplied CD-ROM into the CDROM drive of the computer.

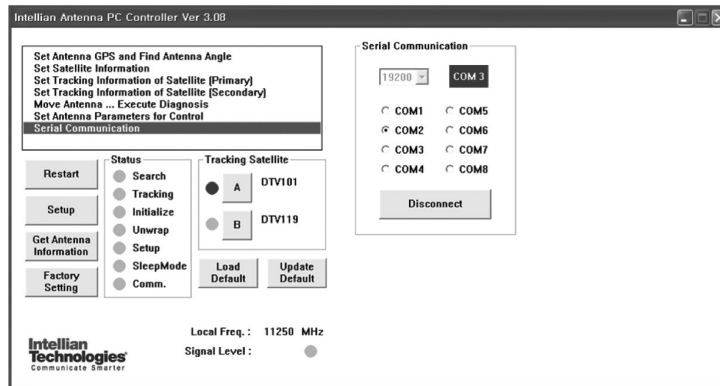

Figure 21 : Intellian Antenna PC Controller Program

Program Initialing and Serial Port Setup

Data communication between the ACU and antenna must be established as the first step in order to start setting your antenna.

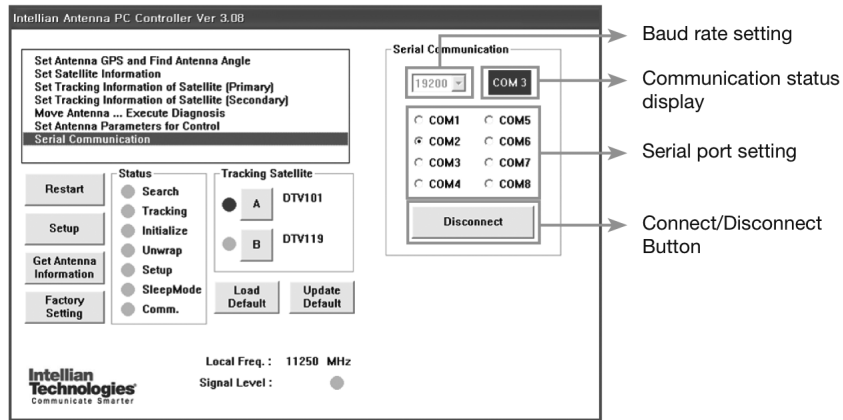

Figure 22 : Setup for Serial Communication

Command Buttons

- Baud Rate Setting – To display data communication speed.
- Communication Status Display – To display data communication between ACU and PC.
- Serial Port Setting – To select serial port to be used.
- Connect / Disconnect – To establish connection between ACU and PC.

Main Menu

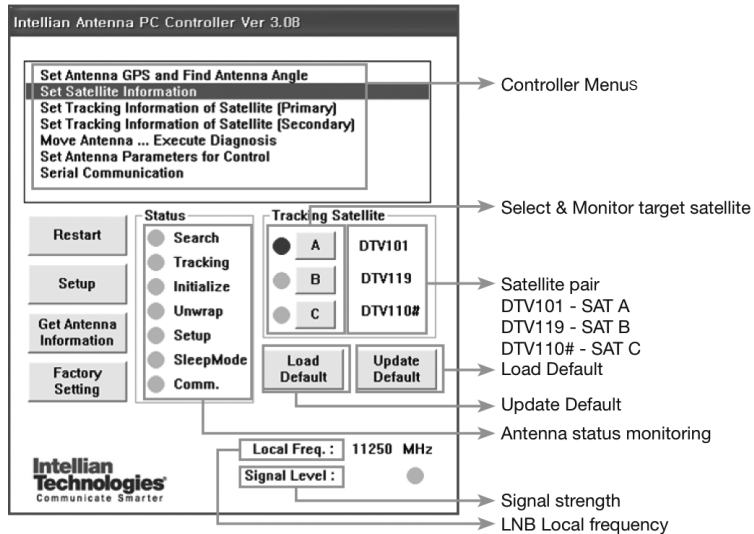

Figure 23 : Main Menu

Antenna Status Monitoring

- Search – Antenna is searching for the selected satellite.
- Tracking – Antenna is tracking the selected satellite.
- Initialize – Antenna or the ACU is initializing.
- Unwrap – Antenna is unwinding/winding the cable in the antenna.
- Setup – Antenna is in setup mode.
- Comm. – Antenna is communicating with the ACU.

Command Buttons

- Restart – To exit setup mode and restart antenna again.
- Setup – To enter the setup mode.
- Get Antenna Information – To indicate the information on display after receiving input from the antenna.
- Factory Setting – To initialize all antenna information to default as it was in the factory status.
- Load Default – To select the regional library on PC program.
- Update Default – To update the antenna using the selected regional library on PC program.

Set Region

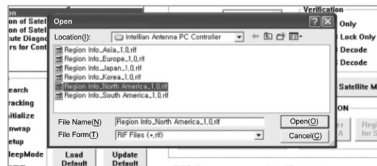

Figure 24 : Load Regional Library

1. Load default: Click “Load Default” button to select satellite library (*.rif file) according to your current region.

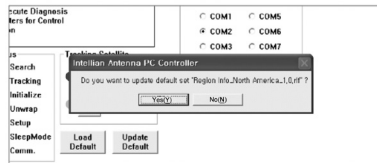

Figure 25 : Confirm the Update

2. Update default: Click “Update Default” button to open update default dialogue. Click “YES” button to update the system.

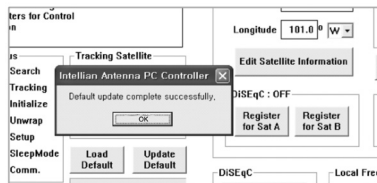

Figure 26 : Updates Completed

3. Click “OK” button to complete the update.

Controller Menu

Set Antenna GPS and Find Antenna Angle

Antenna makes use of GPS information to search satellite faster. More precise the GPS information is, quicker the antenna is able to search for a satellite. The method to input information into GPS is to push “Set GPS” button after keying in the latitude and longitude information on “City GPS”. Pushing “Add City” button stores the GPS information. By selecting the stored region in the list box, the GPS information of each region is displayed. The Intellian satellite TV antenna system utilizes GPS data to locate the satellite faster.

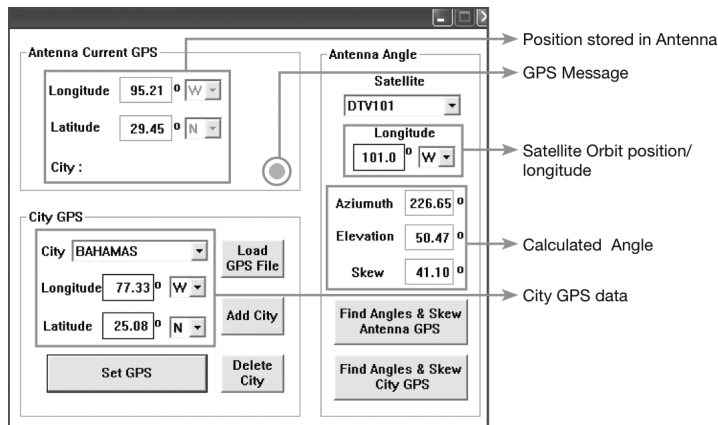

Figure 27 : Antenna Angle and GPS Information

Command Buttons

- Load GPS Files – Reads various city information from the GPS files.
- Add City – Adds the name of city and its GPS information to GPS files.
- Delete City – Deletes the name of city and its GPS information from the GPS files.
- Set GPS – Inputs the indicated GPS information on display to antenna.
- Find Angles & Skew Antenna GPS – Finds the current antenna angle and skew angle in relation to the longitude (orbit position) of satellite and antenna current GPS.
- Find Angles & Skew City GPS – Finds the current antenna angle and skew angle in relation to the longitude (orbit position) of satellite and city GPS.

Setting Satellite Information

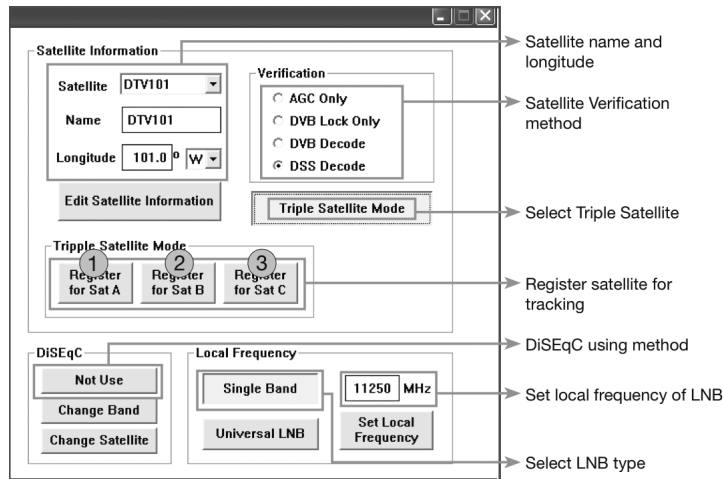

Figure 28 : Setup for Satellite Information

- **Satellite Information**

The name, longitude and confirmation method of the satellite is displayed when a satellite is selected in the list box. Push "Edit Satellite Information" button to update the information on modifying the value.

- **DiSEqC**

When the operation method of DiSEqC is selected to "Change Band", DiSEqC may be used for updating the local frequency and to "Change Satellite", for updating the target satellite.

- **Registration of target satellite.**

Pushing **1** or **2** button after selecting the satellite in the list box makes it possible to register A or B in Dual-sat mode.

Pushing **1** or **2** or **3** button after selecting the satellite in the list box makes it possible to register A or B or C in Tri-sat mode.

- **Local Frequency**

In case that DiSEqC is selected to "Change Band", be sure to push the "Universal LNB" button. In case that the DiSEqC is selected to "Not Use" or "Change Satellite", be sure to push "Single Band" button and input the Local Frequency, and then push "Set Local Frequency" button.

Intellian Satellite TV Antenna Systems

Command Buttons

- Edit Satellite Information – To modify the satellite information.
- Register for Sat A – To register a satellite to satellite A.
- Register for Sat B – To register a satellite to satellite B.
- Register for Sat C – To register a satellite to satellite C. (Tri- Sat Mode)
- Not Use – To not use DiSEqC.
- Change Band – To use DiSEqC to change band.
- Change Satellite – To use DiSEqC to change the satellite.
- Single Band – Antenna in use of single band LNB.
- Universal Band – Antenna in use of universal LNB.
- Set Local Frequency – To select local frequency of LNB.

Set Tracking Information of Satellite [Primary]

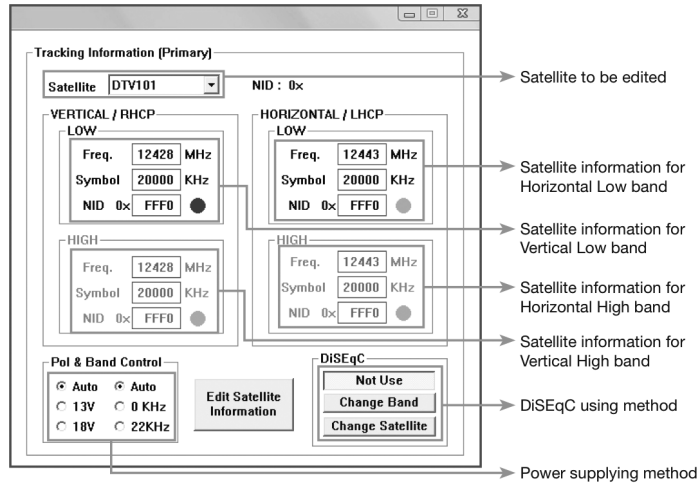

Figure 29 : Setting up the Primary Tracking Information

Command Buttons

- Edit Satellite Information – To change frequency information of the antenna.
- Satellite Information – Satellite information consists of frequency, symbol and NID (Network ID) of a transponder in tracking satellite. There are four groups of satellite information. 'Vertical/RHCP' is applied when Receiver supplies 13V. 'Horizontal/LHCP' is applied when Receiver supplies 18V. 'LOW' is applied when DiSEqC signal is not detected from Receiver. 'HIGH' is applied when DiSEqC signal is detected from Receiver.

If you select 'Not Use' or 'Change Satellite', two 'HIGH' groups are inactivated. If you select 'Change Band', two 'HIGH' groups are activated and you can modify satellite information which is applied when DiSEqC signal is detected from Receiver. After modifying information, press 'Edit Satellite Information' button, then new information is updated in the antenna.

- Pol & Band Control

The "Pol" controls 13V (Vertical/RHCP band) and 18V (Horizontal/ LHCP band). The "Band" controls DiSEqC 0KHz tone (Low band) and 22KHz tone (High band).

Set Tracking Information of Satellite [Secondary]

Voltage		DiSEqC		Discription
13V	18V	0KHz	22KHz	
AUTO	AUTO	AUTO	AUTO	13V & 18V and DiSEqC 0KHz & 22KHz tone to LNB
AUTO	AUTO	•		13V & 18V and DiSEqC 0KHz tone to LNB
AUTO	AUTO		•	13V & 18V and DiSEqC 22KHz tone to LNB
•		AUTO	AUTO	13V and DiSEqC 0KHz & 22KHz tone to LNB
•		•		13V and DiSEqC 0KHz tone to LNB
•			•	13V and DiSEqC 22KHz tone to LNB
	•	AUTO	AUTO	18V and DiSEqC 0KHz & 22KHz tone to LNB
	•			18V and DiSEqC 0KHz tone to LNB
	•	•		18V and DiSEqC 22KHz tone to LNB

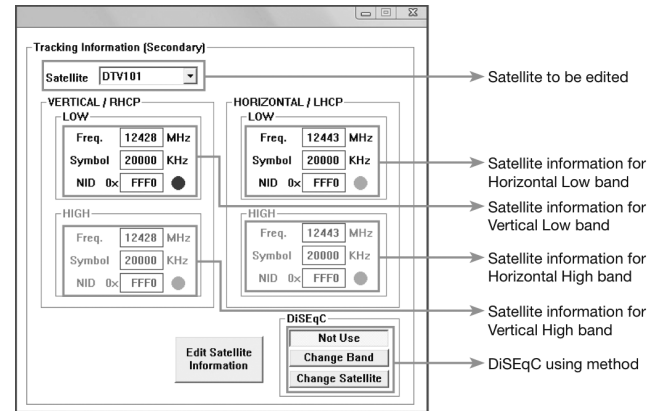

Figure 30 : Setting up the Secondary Tracking Information

Command Buttons

- Edit Satellite Information – To change frequency information of the antenna.

Figure 37 : Antenna Diagnosis

Move Antenna and Execute Antenna Diagnosis

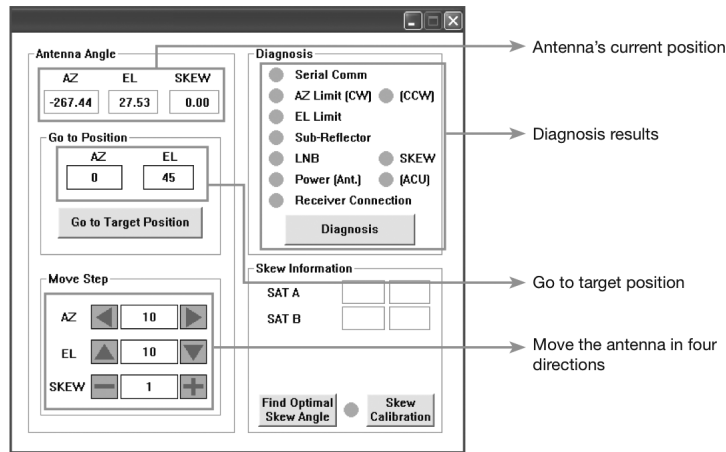

Figure 31 : Antenna Diagnosis

• Angle of Antenna

Two kinds of antenna movement is available. One is to move by the target position and the other is to move by certain amount of angle. The current position (angle) of the antenna is displayed as "Current" and to move to the target position, push "Go to target Position" button after keying in desired angle into "Target". To move to a certain amount of angle only, move antenna to direction of up or down, and CW or CCW by using $\blacktriangle\blacktriangleright\blacktriangleleft\blacktriangleright$ buttons after keying in the desired angle into the AZ and EL in the "Move Step" box. Rotate LNB to direct the skew angle by using + - button (i4P only).

• Self-Diagnosis

If the "Diagnosis" button is pressed, it displays the results of the self- diagnosis after the test is completed. The blue circle means the antenna is normal; red represents abnormal and green represents the antenna is under diagnosis.

Command Buttons

- Go to Target Position – To move the antenna to the present position.
- Diagnosis – To diagnose the antenna (BLUE – Passed, RED – Failed, GREEN – Under diagnosis)

Intellian Satellite TV Antenna Systems

Set Antenna Parameters for Control

It is not recommended for a novice satellite service user to use this mode. Consult Intellian for changing antenna parameters.

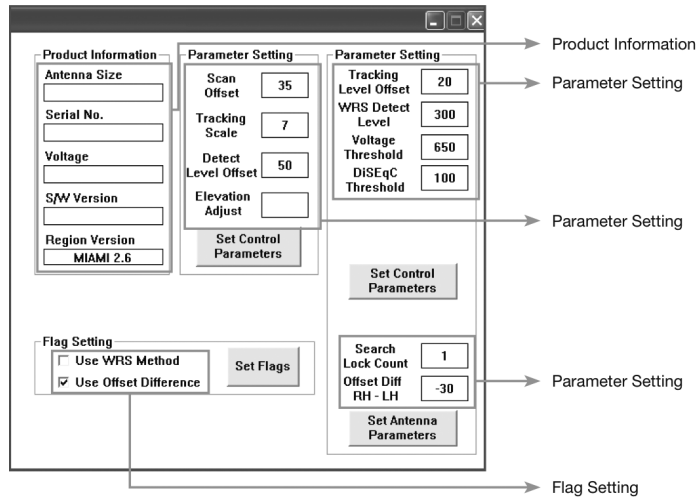

Figure 32 : Antenna Parameters

Command Buttons

- Set Control Parameter – To register parameters value.
- Set Flags – To set flag setting for WRS method or offset difference.

Parameter Setting - To set antenna parameter values.

Scan Offset The scan offset is to offset the angle difference between the black marker on the sub-reflector and the optical sensor.

Track Scale The track scale is to control the tracking speed while antenna is tracking the satellite.

Detect Level The detect level is to set the satellite signal detection level.

WRS Level The WRS level is to set the WRS detection level.

Track Offset The tracking offset is to offset the satellite signal tracking level.

Power Level The power level is to distinguish the voltage between 13 V and 18 V.

DiSEqC Level The DiSEqC level is to distinguish 0KHz tone and 22KHz tone.

Offset RH-LH The offset RH-LH is to offset the signal difference between RHCP and LHCP.

EL Offset The EL offset is to offset the angle difference between the mechanical elevation angle and actual elevation angle.

Use WRS Use WRS is to determine whether the system uses WRS level or not. "Use WRS" and "WRS Level" are pair functions.

Offset Difference Offset difference is to determine whether the system to uses "Offset RH-LH" or not. "Offset Difference" and "Offset RH-LH" are pair functions.

Preparation for Transportation

This is to describe how to prepare the antenna internally for transportation.

The following procedures to secure the antenna shall be strictly observed to protect it from being damaged during transportation.

1. Refer to the drawing on the right.
2. Rotate antenna left and right slowly until the limit switch is pressed.
3. Turn the antenna by 360° to the reverse direction.
4. Insert the restraint foam to secure the pedestal in position with the bottom radome.
5. Cover upper part of radome. Be careful not to touch the reflector when assembling upper part of radome.
6. Pack Intellian i4 Inland into the original package box.

NOTE : Don't rotate it quickly, or you may damage the antenna limit system.

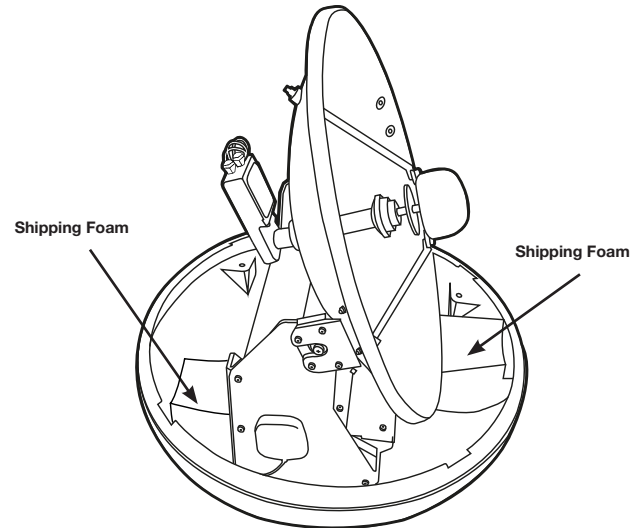

Figure 34 : Preparation for Transportation

Warranty

Intellian systems are warranted against defects in parts and workmanship, these warranties cover THREE (3) YEAR of parts and TWO (2) YEAR of factory repair labor to return the system to its original operational specification.

Warranty periods commence from the date of shipment from Intellian facility, or date of installation which is come sooner. Providing maximum 6 months Warranty additionally if submission of authorized form which is described installation occurs within 6 months from the shipment date.

Intellian Technologies warranty does not apply to product that has been damaged and subjected to accident, abuse, misuse, non-authorized modification, incorrect and/or non-authorized service, or to a product on which the serial number has been altered, mutilated or removed. Intellian Technologies, will (at its sole discretion) repair or replace during the warranty period any product which is proven to be defective in materials or workmanship, in accordance with the relevant product warranty policy. All products returned to Intellian Technologies, during the warranty period must be accompanied by a Service Case reference number issued by the dealer/distributor from Intellian Technologies, and (where applicable) a copy of the purchase receipt as a proof of purchase date, prior to shipment. Alternatively, you may bring the product to an authorized Intellian Technologies, dealer/distributor for repair.

Appendix : i4 Inland Technical Specification

General	
Approvals	
CE – conforms to	EU Directive 89/336/EEC
FCC – verified to	CFR47:Part 15
Dimensions	
Satellite antenna unit	50cm (19.7”) x 54cm(21.2”)
Antenna dish diameter	45cm(17.7”)
Antenna control unit	17.8cm(7”)x21.7cm(8.5”)x5.4cm(2.1”)
Weight	
Satellite antenna unit	11.6kg (21.5 lbs)
Antenna control unit	1.2kg (2.6 lbs)
Environmental	
Operating temperature range	-15°C to +55°C (+5°F to +131°F)
Storage temperature range	-25°C to +70°C (-13°F to +158°F)
Humidity limit	95% R.H
Operating voltage	
Operating voltage	100V ~ 220V AC
Power consumption	
Power consumption	Typ. 30W, Max. 50W

Antenna system performance	
Frequency	Ku-band (10.7 to 12.75 GHz)
Minimum EIRP	49dBW
Azimuth range	680°
Elevation range	0° ~ +90°
Ship's motion	Roll ±25° Pitch ±15°
Roll and pitch response rate	50° per second
Turn rate	50° per second
